

# Starbox 星形箱

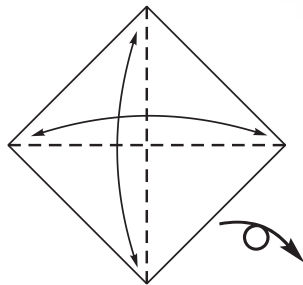

**1** Start with the side you want to be inside the box facing up. Fold in half, corner-to-corner, in both directions. Unfold. Turn the paper over.

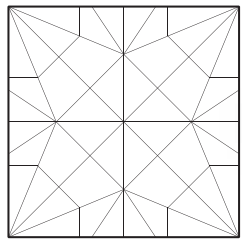
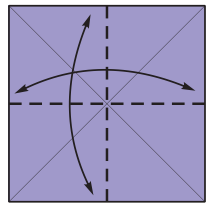

**2** Fold in half, side-to-side, in both directions. Unfold.

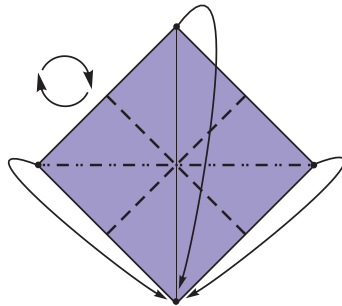

**3** Rotate the paper. Collapse the model by bringing all four corners together, and then flattening.

## INTERMEDIATE LEVEL

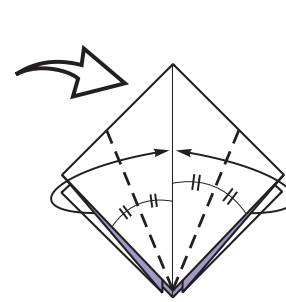

**4** The completed step with image enlarged. Fold each side of the top layer to the center.

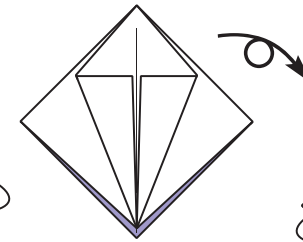

**5** The completed step.

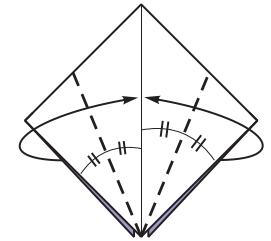

**6** Turn the model over, and repeat step 4 on this side.

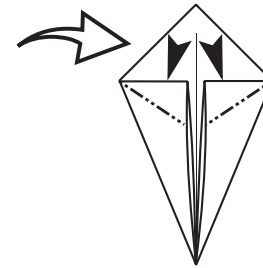

**7** Squash the top folded edges.

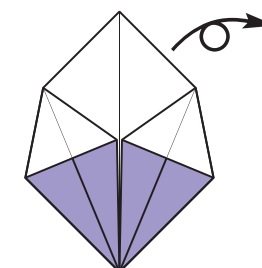

**8** The completed step. Turn the model over.

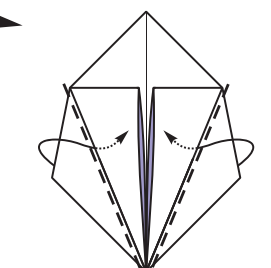

**9** Fold the left and right sections over the main part of the model, and tuck the sections beneath the top layer.

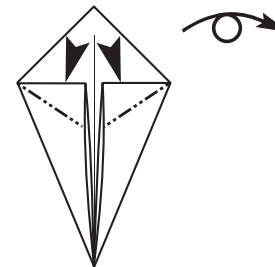

**10** Squash the top folded edges. Turn the model over.

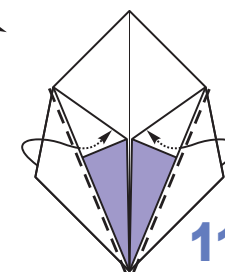

**11** Repeat step 9.

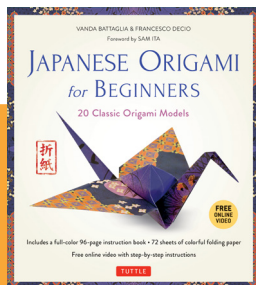

Find this fold in our **Japanese Origami for Beginners Kit!**

Follow the QR code for a video tutorial

CONT. ON NEXT PAGE

SHARE YOUR WORK WITH US ONLINE!  
tag us @Tuttlepublishing and use hashtags  
#TuttleOrigami & #TuttleOrigamiContest

**TUTTLE**  
tuttlepublishing.com

# INTERMEDIATE LEVEL

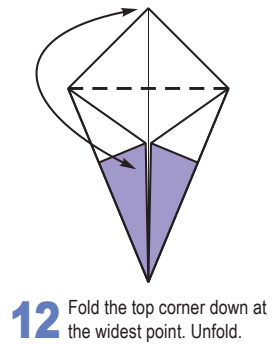

**12** Fold the top corner down at the widest point. Unfold.

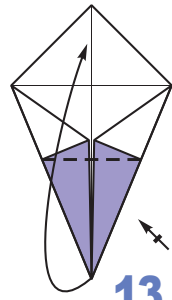

**13** Fold the bottom of the top layer up as far as it will go. Unfold. Repeat on the other side.

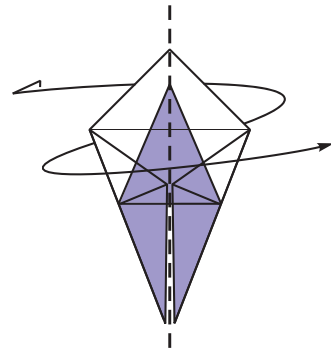

**14** Fold the top layer in half by bringing the left side over the right side. Turn the model over and repeat on the other side.

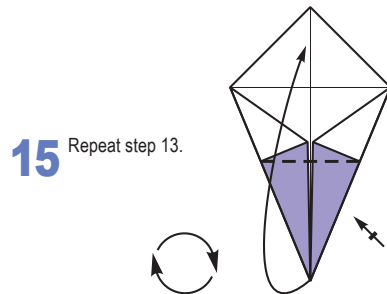

**15** Repeat step 13.

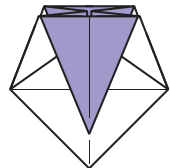

**16** The completed step.

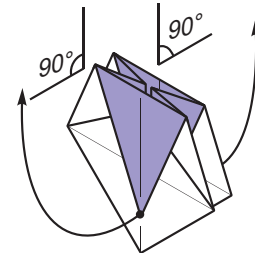

**17** New view. Lift the flaps folded in step 15 up.

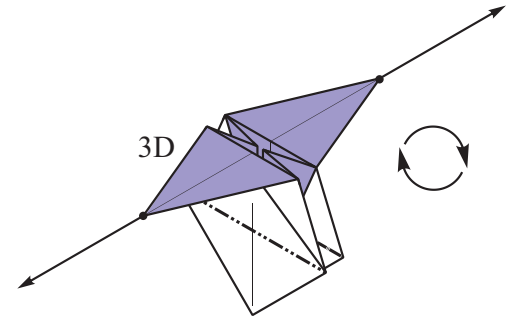

**18** Gently pull the flaps out. As the flaps on the other sides are exposed, lift them up. Flatten the bottom of the box.

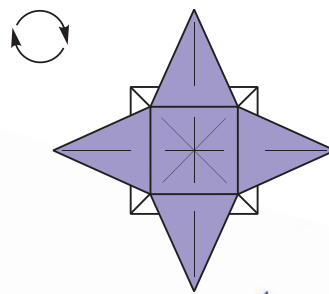

**19** The completed step.

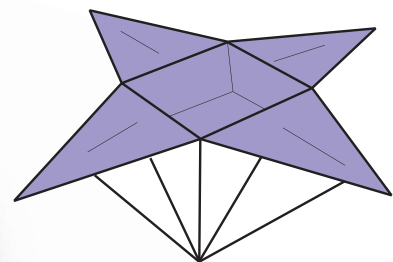
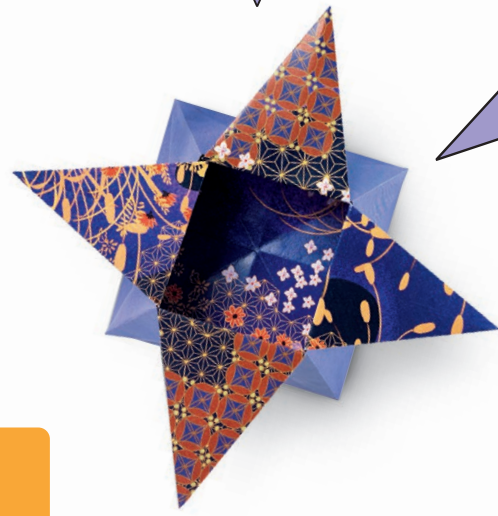

**20** The completed Starbox.



Find this fold in our **Japanese Origami for Beginners Kit!**  
Follow the QR code for a video tutorial

**SHARE YOUR WORK WITH US ONLINE!**  
tag us @Tuttlepublishing and use hashtags  
#TuttleOrigami & #TuttleOrigamiContest

**TUTTLE**  
tuttlepublishing.com